

LOC		DIST		REVISIONS			
P	LTN	DESCRIPTION	DATE	DWN	APVD		
A2		REVISED PER ECR-14-003492	15MAR2014	NK	GJ		

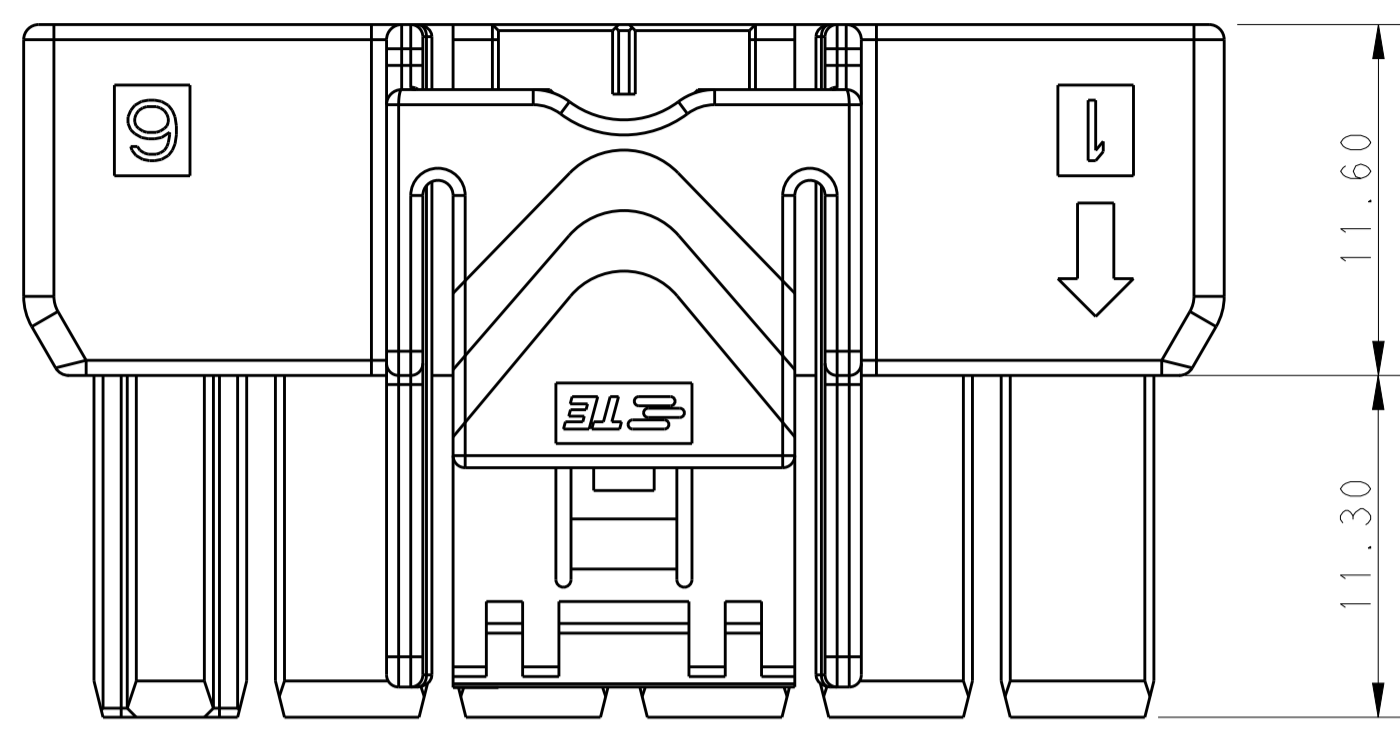

POS.	DIM. A
2*6	39.70
2*5	33.70
2*4	27.70
2*3	21.70

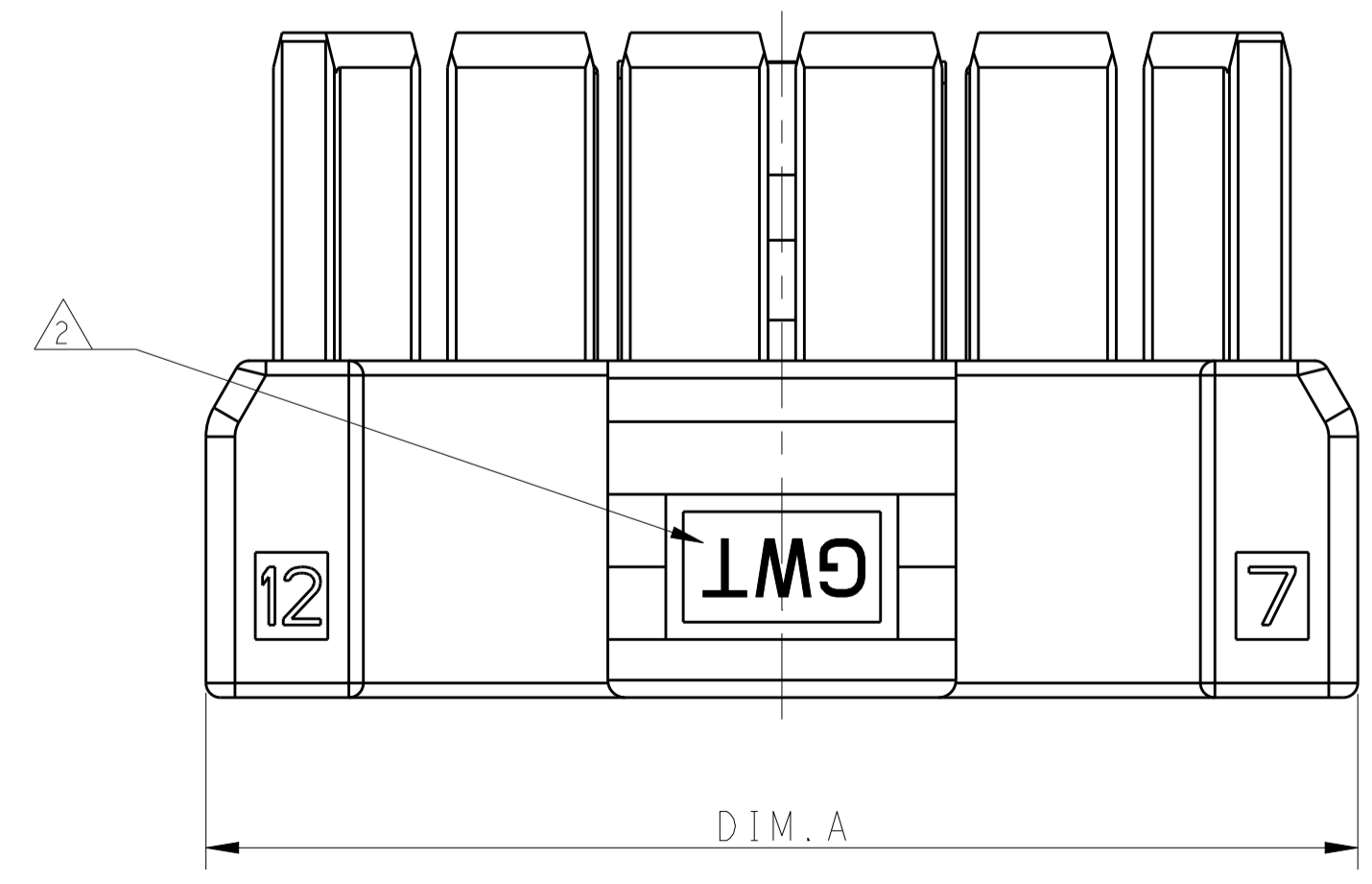
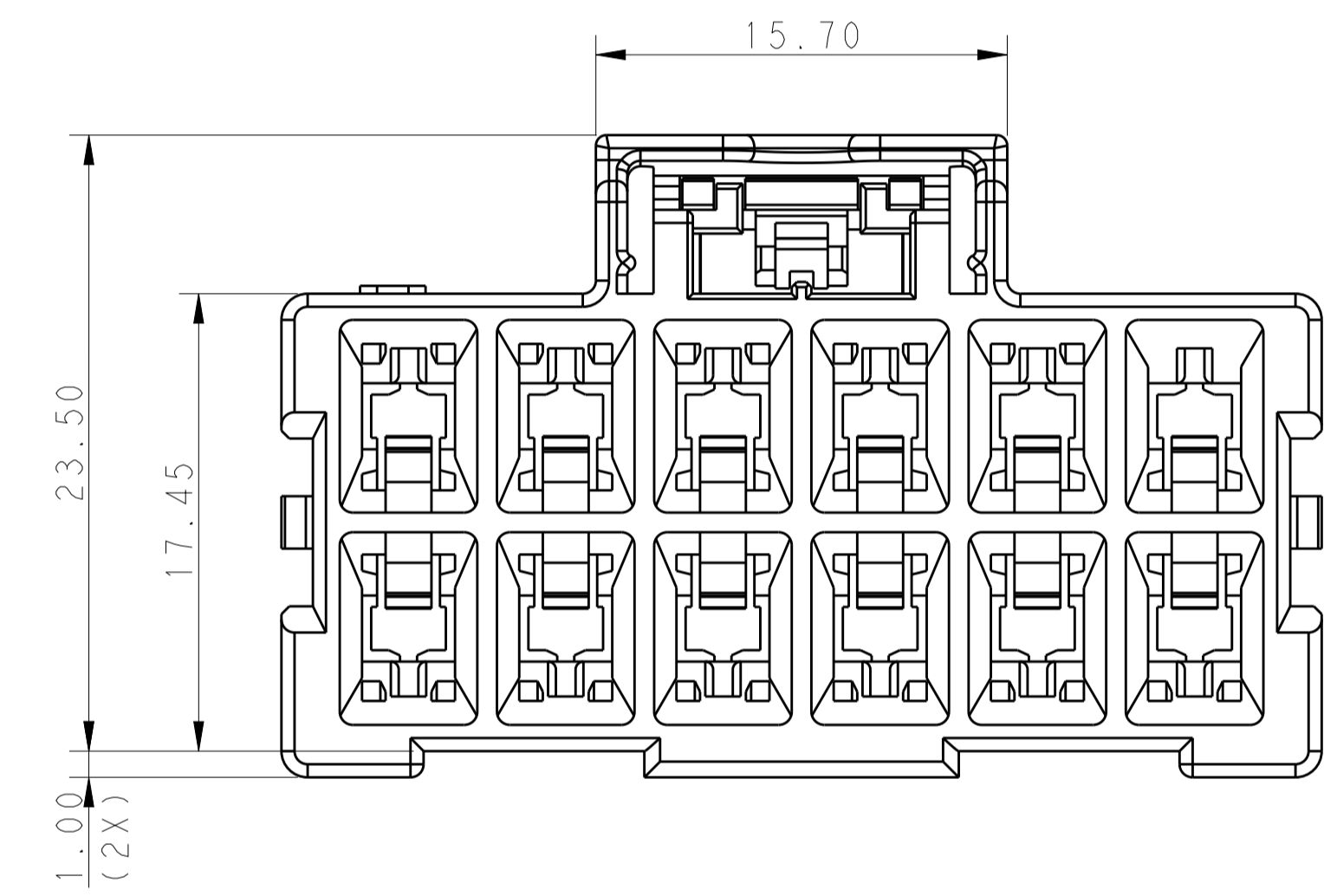
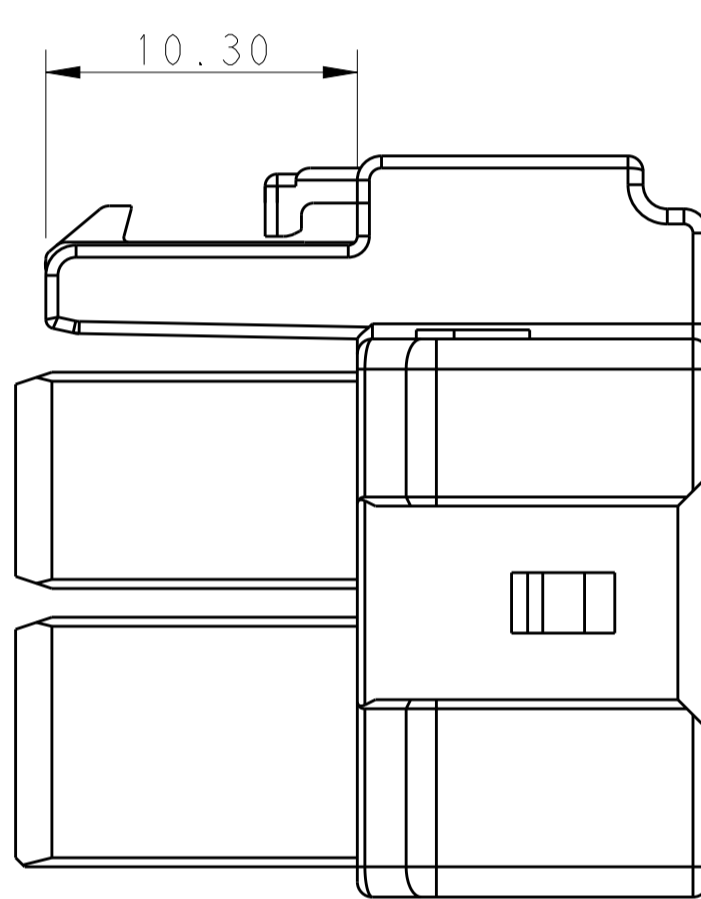
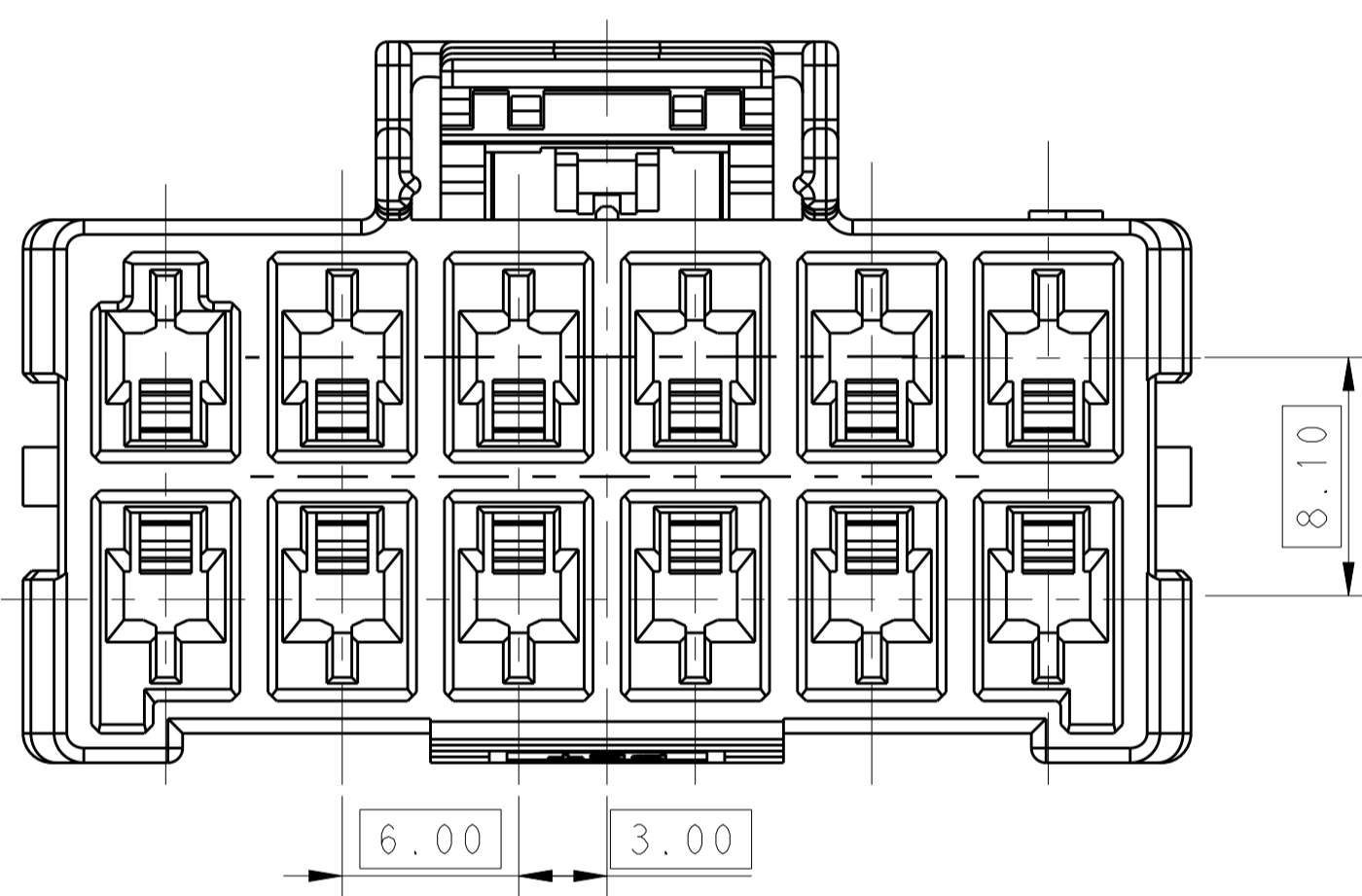

NOTE

- MATERIAL:
 - LEVEL A: PA6, COMPLY WITH GLOW WIRE REQUIREMENTS FOR PARTS OF NON-METALLIC MATERIAL SUPPORTING A CURRENT-CARRYING CONNECTION DETAILED IN IEC 60335-1, SECTION 30 (GWT), UL 94V-0
 - LEVEL B: PBT, HOT WIRE IGNITION (HWI) VERSION ARE MOLDED IN A RESIN THAT COMPLIES WITH TE HOT WIRE IGNITION TEST 109-32026 AND ARE RECOMMENDED FOR USE WITH HWI HOUSINGS THAT ALSO COMPLY, UL 94V-0

- MATERIAL MARK:
 - LEVEL A:GWT,LEVEL B:HWT

- APPLICABLE CONTACT P/N
 REC CONTACT:1971237/1971779/81/83/85/87-*

- MATING CONN, P/N
 CAP HSG: *-2232359/264-
 DOUBLE LOCK PLATE: *-1971778-*

5. This product has not completed validation testing.

THIS DRAWING IS A CONTROLLED DOCUMENT.		DWN: TOMMY WU 26MAR2013 CHN: TOMMY WU 26MAR2013 APVD: HAPYE WU 26MAR2013 YIHONG MAO 26MAR2013	TE Connectivity	
DIMENSIONS: mm TOLERANCES UNLESS OTHERWISE SPECIFIED: 0 PLC ± 1 PLC ±0.35 2 PLC ±0.25 3 PLC ± 4 PLC ± ANGLES ±		PRODUCT SPEC: 108-106118 APPLICATION SPEC: 114-106118 WEIGHT: - Customer Drawing	NAME: PLUG HOUSING, DOUBLE ROW POWER TRIPLE LOCK SIZE: A1 CAGE CODE: 00779 DRAWING NO: 2232266 RESTRICTED TO: -	
MATERIAL: -		SCALE: -		SHEET: 1 OF 2
4805 (3/11)				REV: A2

LOC	DIST	REVISIONS			
P	LTN	DESCRIPTION	DATE	DNW	APVD
-	-	SEE SHEET 1	-	-	-

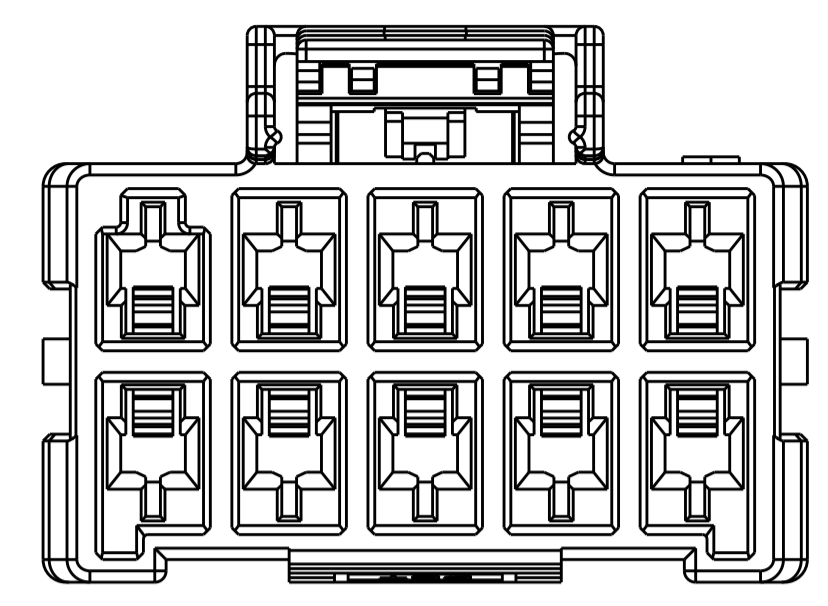
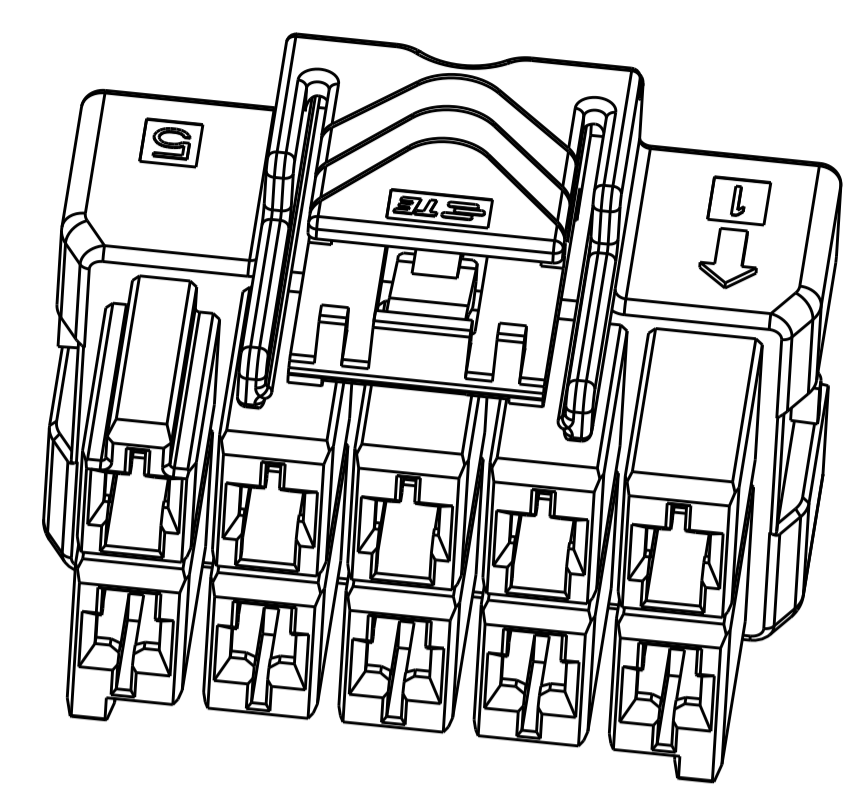

2*5 POSITIONS

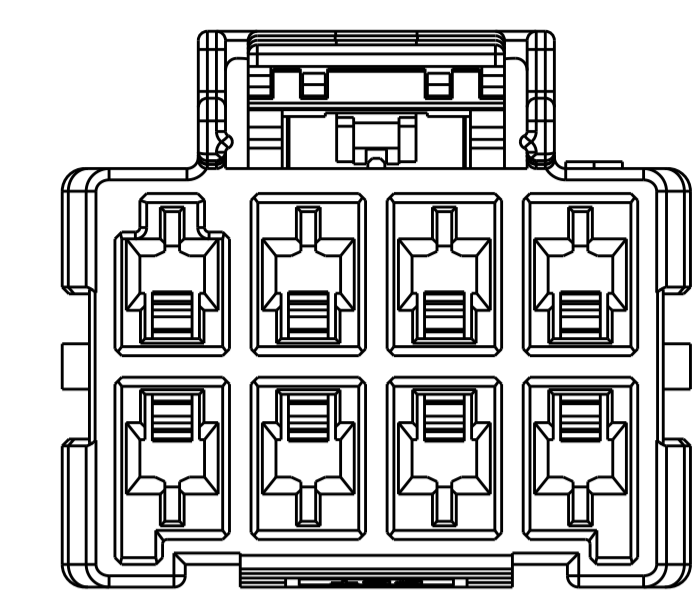
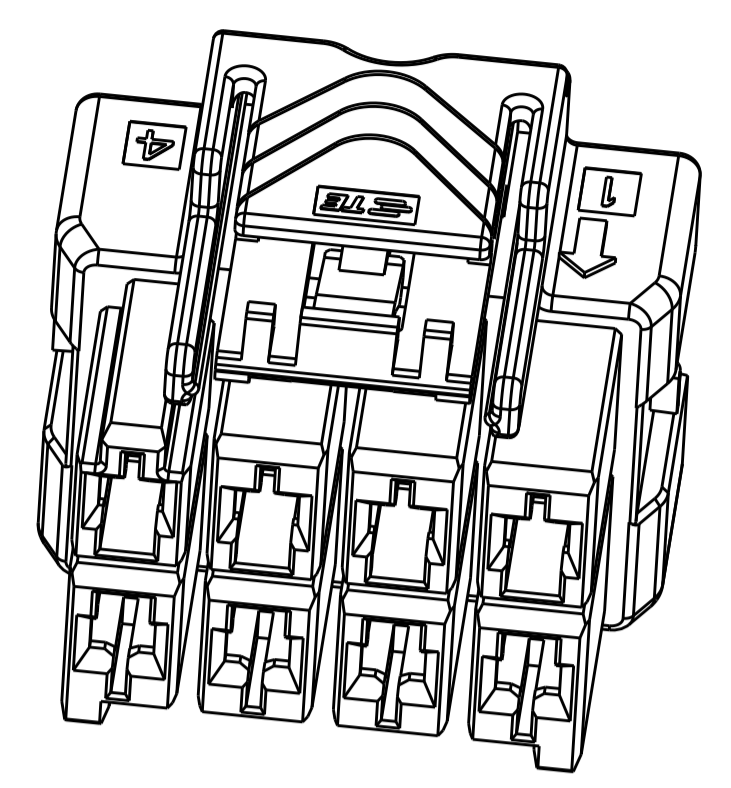

2*4 POSITIONS

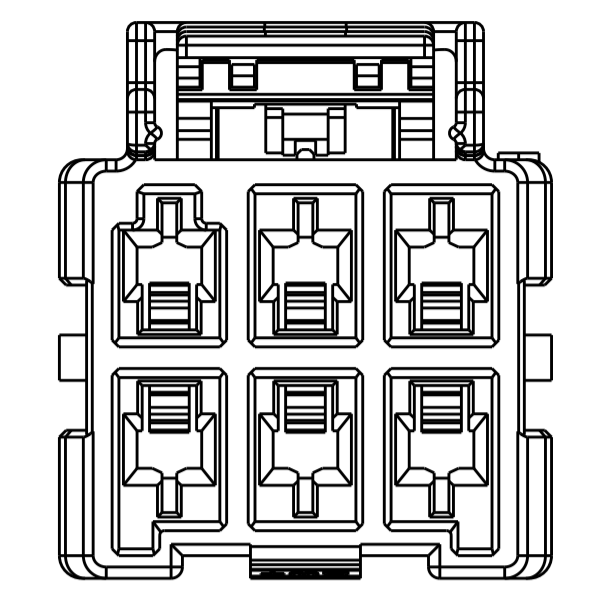
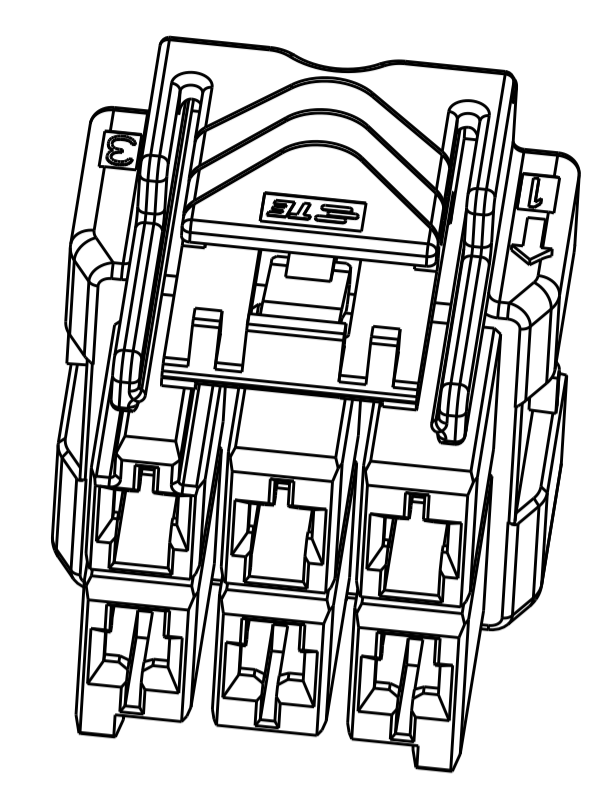

2*3 POSITIONS

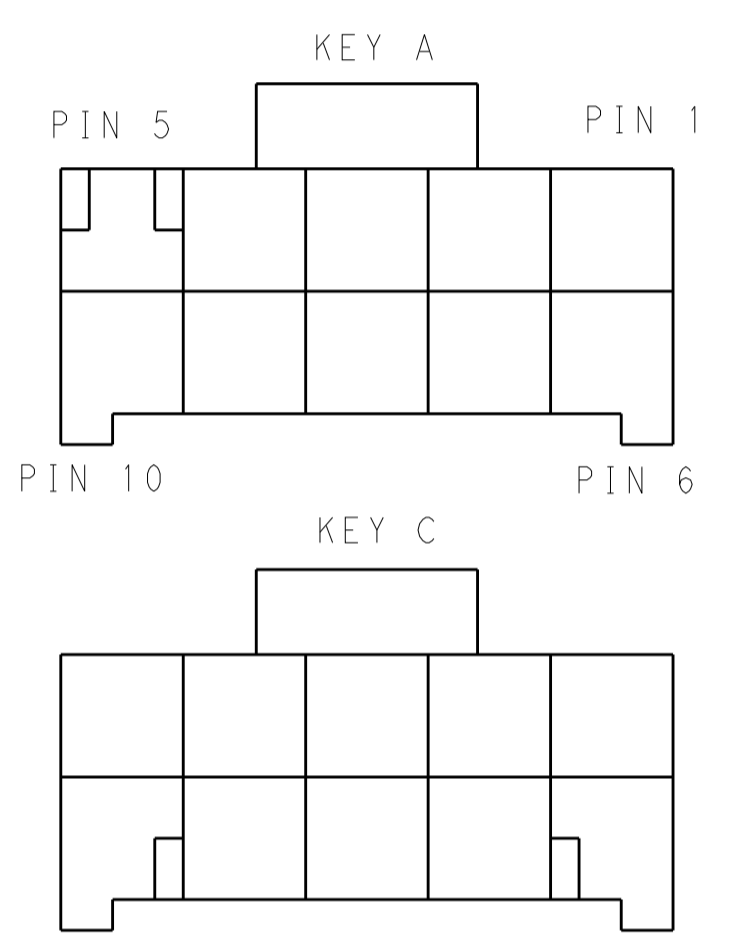

KEYING FOR 2*5 POS.

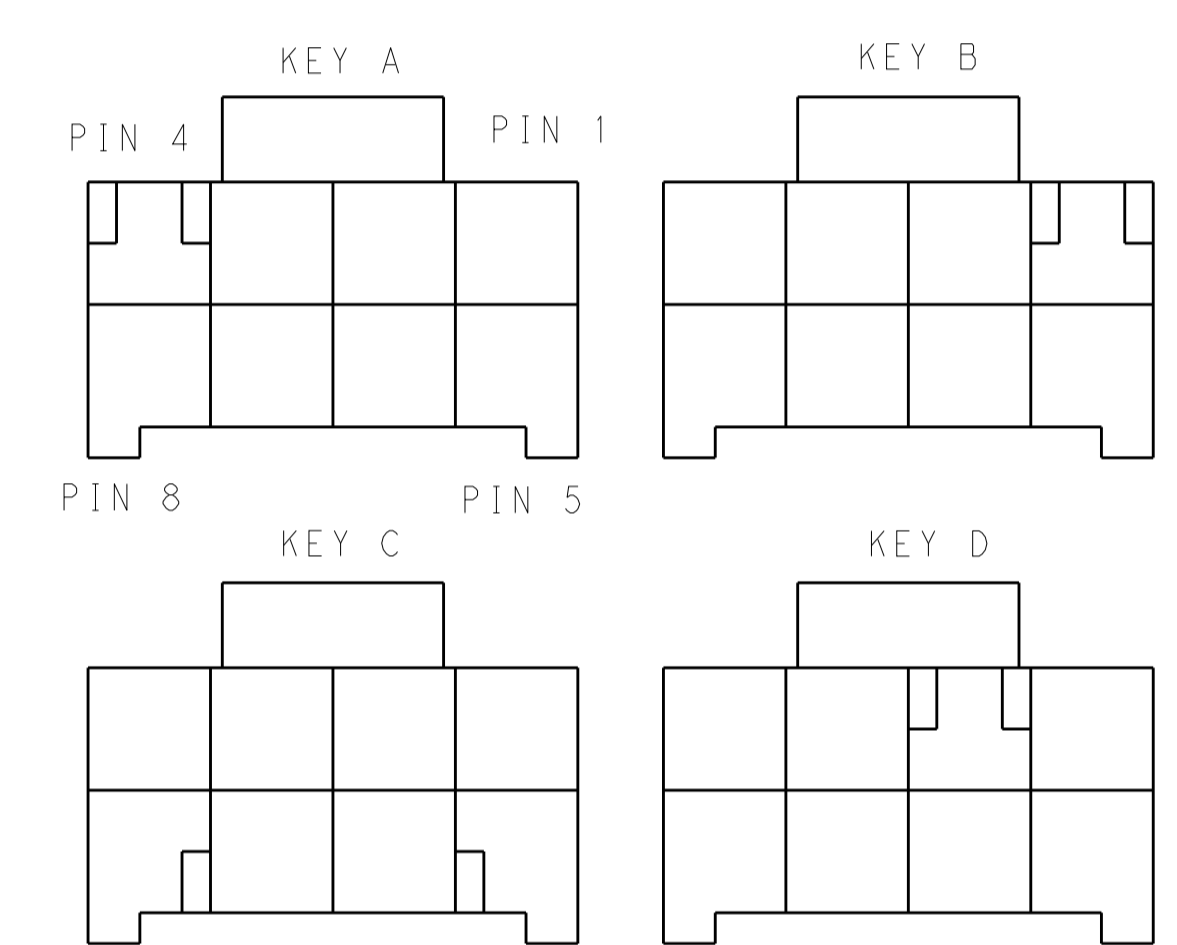

KEYING FOR 2*4 POS.

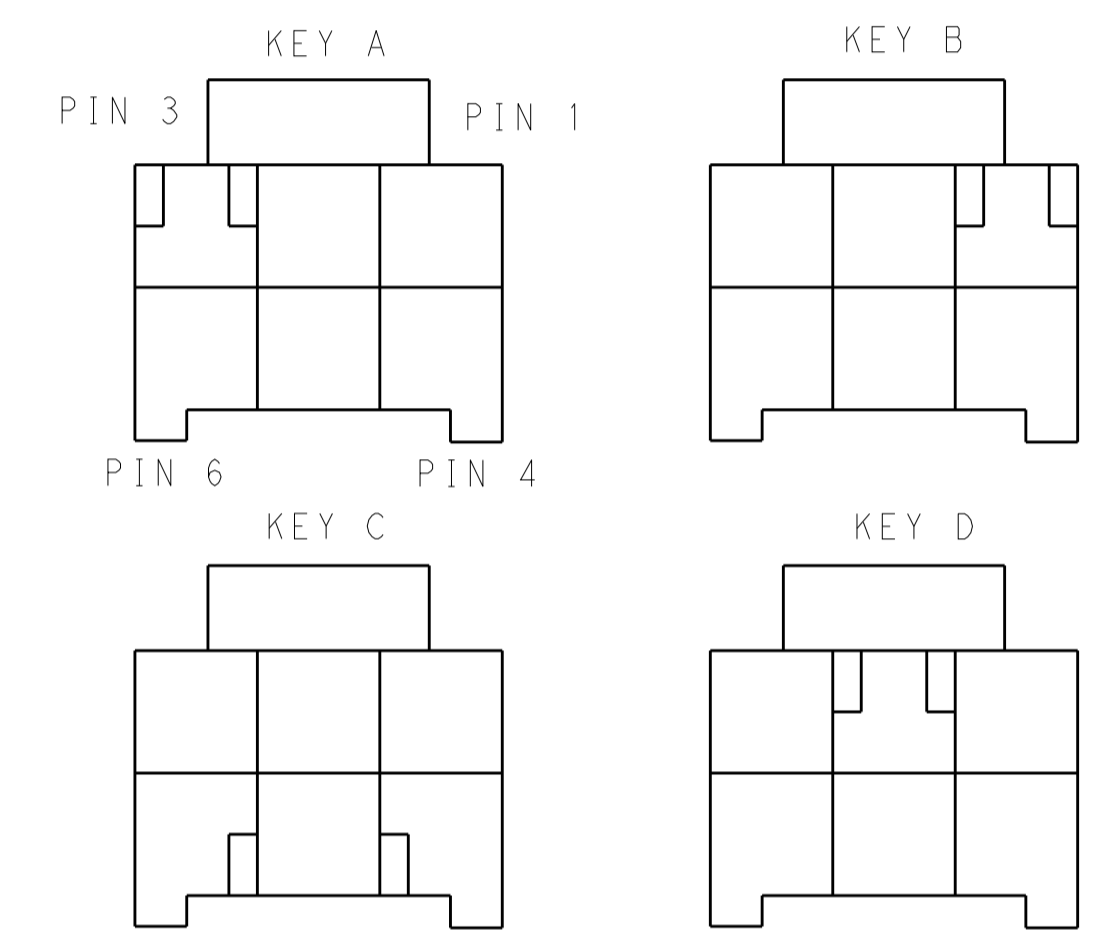

KEYING FOR 2*3 POS.

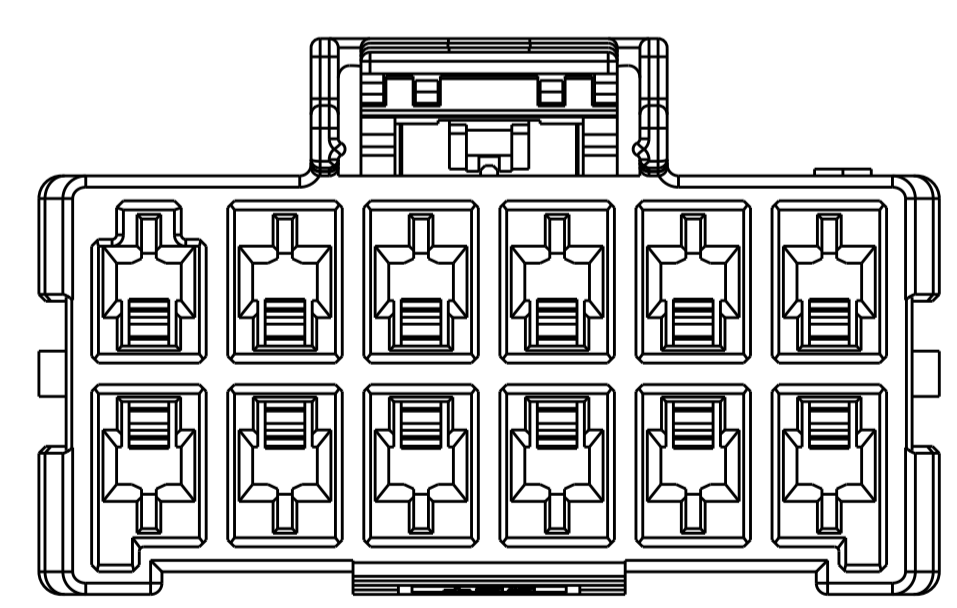
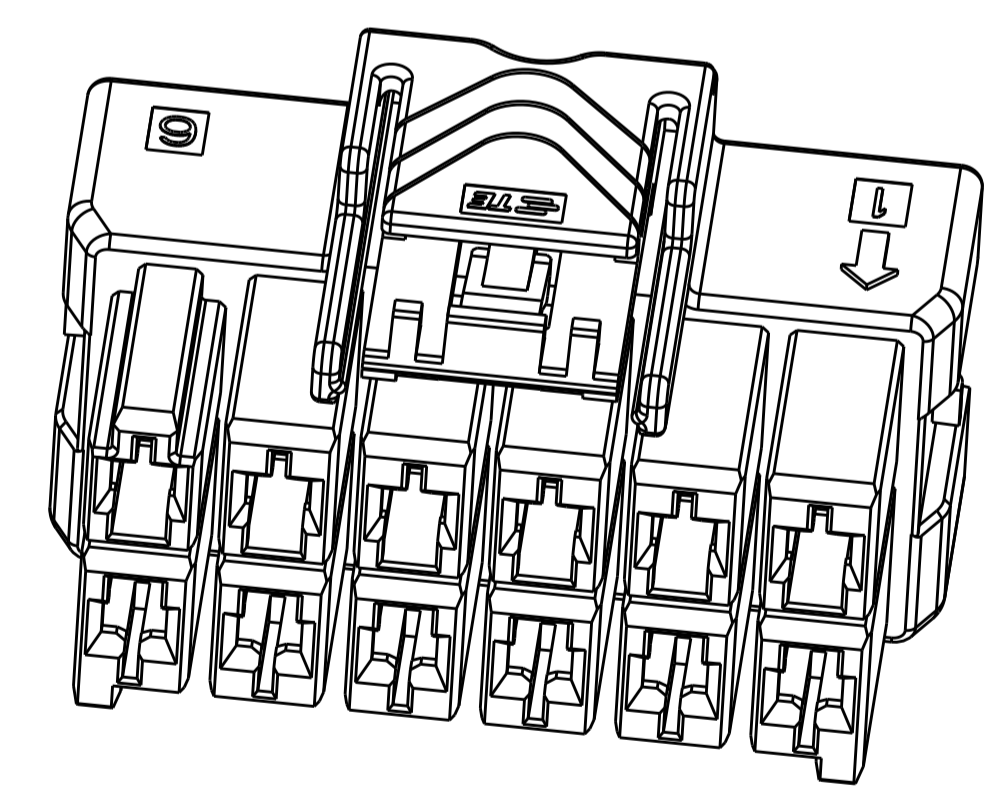

2*6 POSITIONS

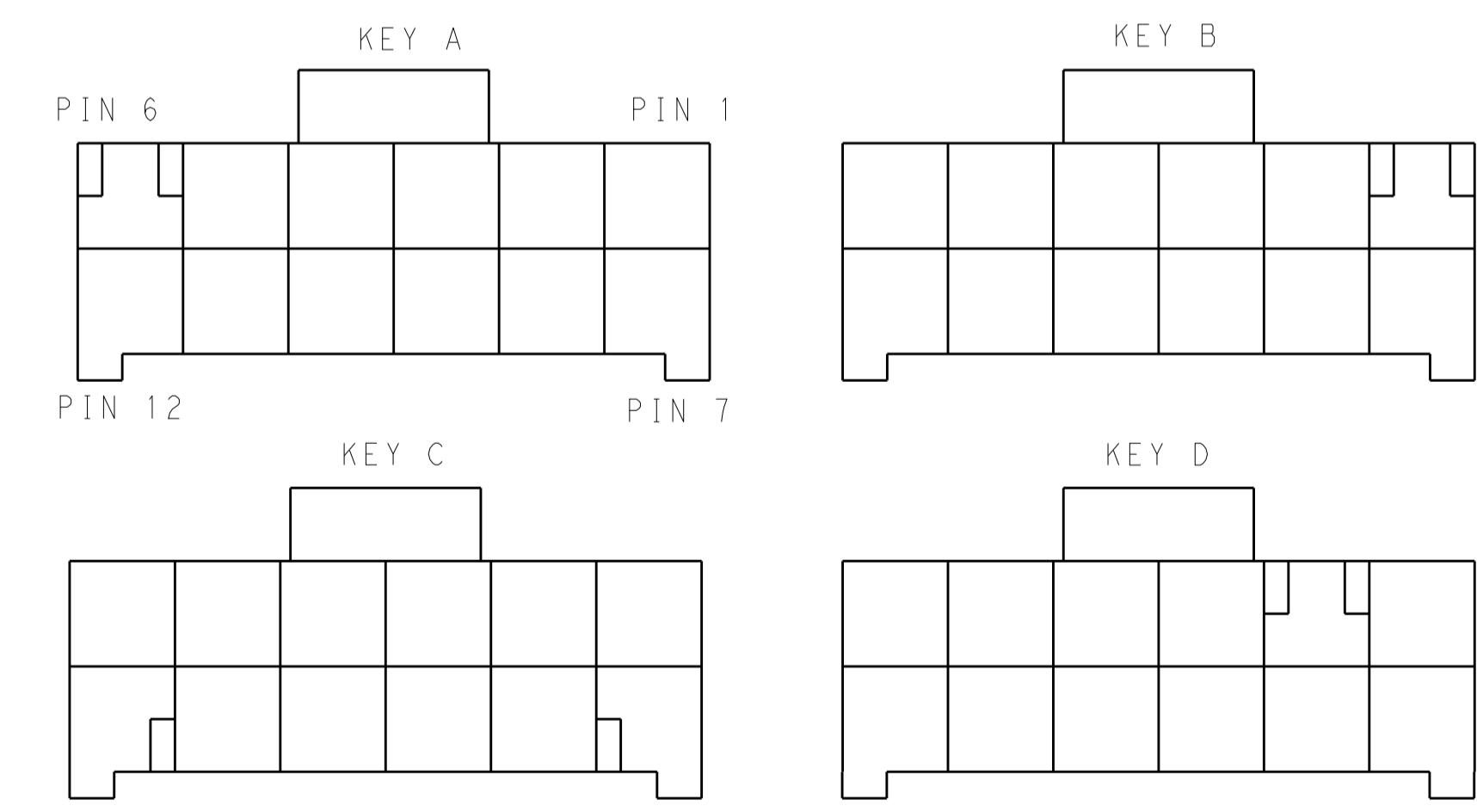

KEYING FOR 2*6 POS.

POS.	MATERIAL	COLOR	KEY	P/N
2*6	LEVEL A	DARK GREY	KEY A	5-2232266-4
		BROWN	KEY B	6-2232266-6
		GREEN	KEY C	7-2232266-6
		ORANGE	KEY D	8-2232266-6
2*5	LEVEL A	DARK GREY	KEY A	5-2232266-5
		BROWN	KEY B	6-2232266-5
		GREEN	KEY C	7-2232266-5
		ORANGE	KEY D	8-2232266-5

POS.	MATERIAL	COLOR	KEY	P/N
2*4	LEVEL A	DARK GREY	KEY A	5-2232266-4
		BROWN	KEY B	6-2232266-4
		GREEN	KEY C	7-2232266-4
		ORANGE	KEY D	8-2232266-4
2*3	LEVEL A	DARK GREY	KEY A	5-2232266-3
		BROWN	KEY B	6-2232266-3
		GREEN	KEY C	7-2232266-3
		ORANGE	KEY D	8-2232266-3
LEVEL B	BLACK	KEY A	1-2232266-1	

THIS DRAWING IS A CONTROLLED DOCUMENT. DWN: TOMMY_WU 26MAR2013
 CHK: HAPYE_WU 26MAR2013
 APVD: YIHONG_MAO 26MAR2013

STE TE Connectivity

PLUG HOUSING, DOUBLE ROW
 POWER TRIPLE LOCK

SIZE: A1 CAGE CODE: 100779 DRAWING NO: 2232266
 SHEET 2 OF 2 REV A2

Customer Drawing